

PB-1/PB-2/PB-3型

■左右勝手あり
本図は右勝手を示す

PB-1型

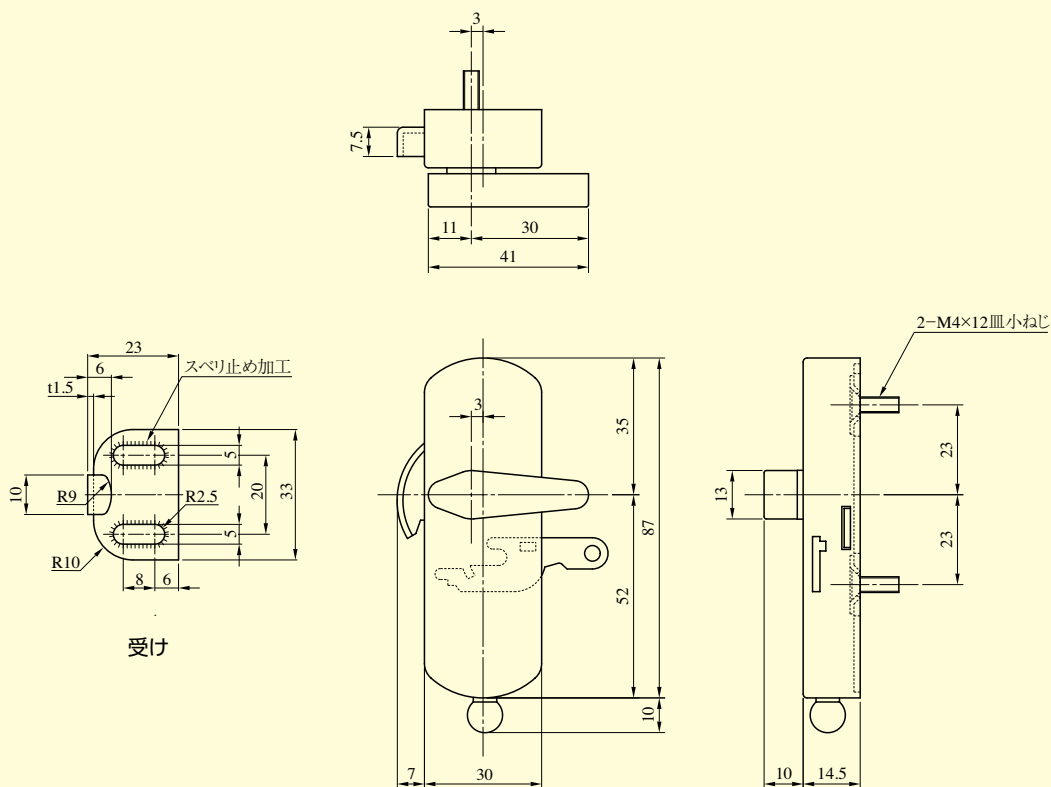

PB-2型

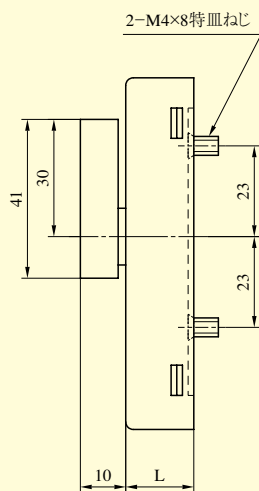
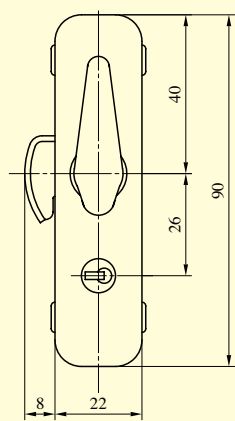
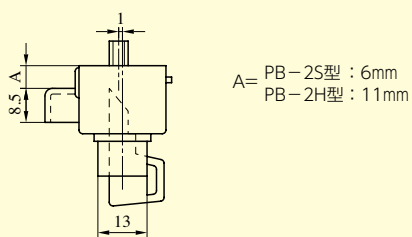

L= PB-2S型: 18mm
PB-2H型: 23mm

PB-3型

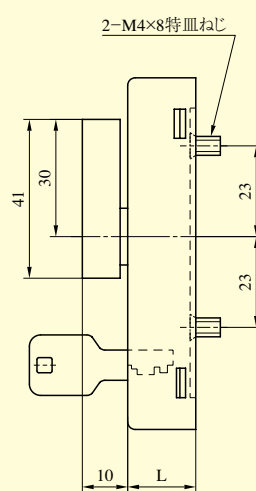
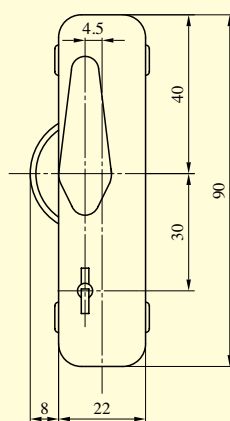
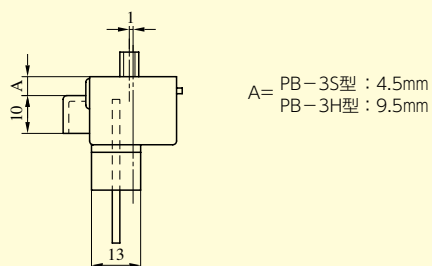

L= PB-3S型: 18mm
PB-3H型: 23mm

PB-1
PB-2
PB-3