

The logo is contained within a rectangular frame with a thick dark blue outer border and a thin white inner border. The text 'C70' is rendered in a large, bold, green sans-serif font, while 'SERIES' is in a smaller, bold, blue sans-serif font below it.

C70
SERIES

LEVER HANDLE

■納期:受注生産品(P3参照)

U9LA7575-1

シリンダー錠

C70



材質:黄銅/仕上:バフ(YB)



材質:黄銅/仕上:サテンクローム(SC)



材質:黄銅/仕上:硫化イブシ(RI)



室内側

●外観寸法図

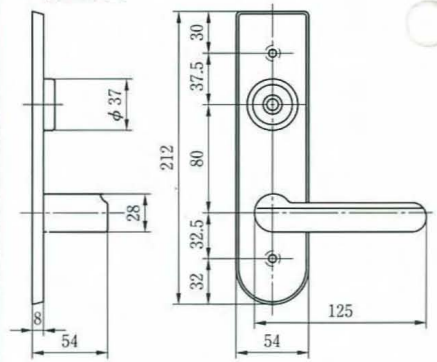

U9LA7577-1

シリンダー錠

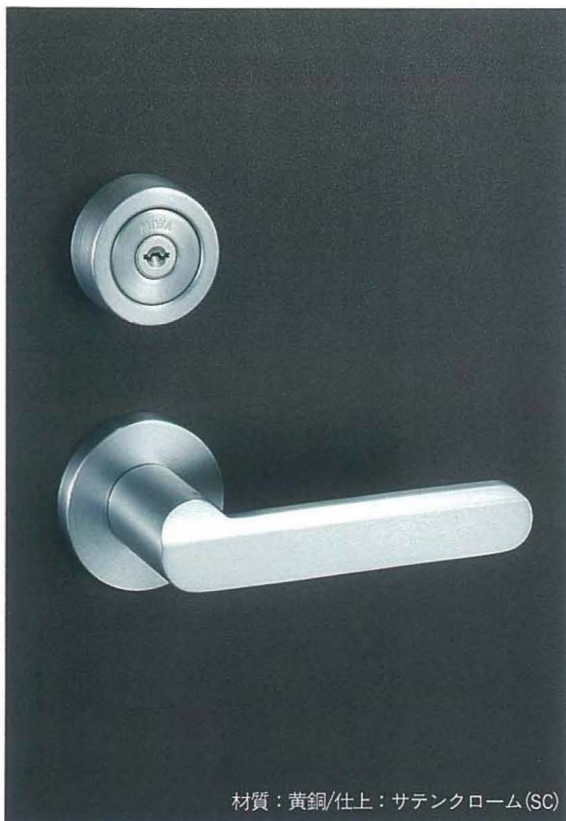

材質:黄銅/仕上:サテンクローム(SC)

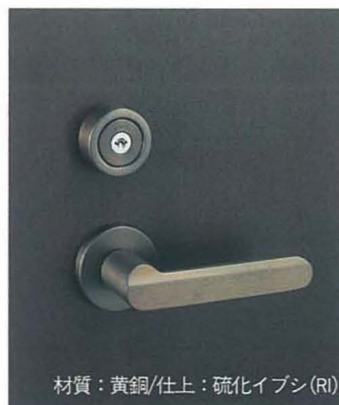

材質:黄銅/仕上:硫化イブシ(RI)

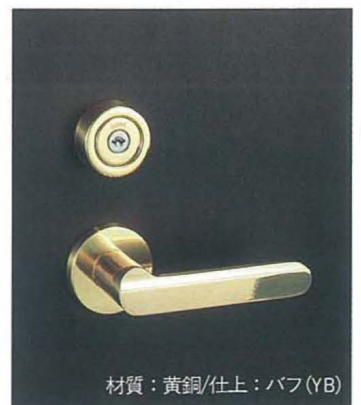

材質:黄銅/仕上:バフ(YB)



室内側

●外観寸法図

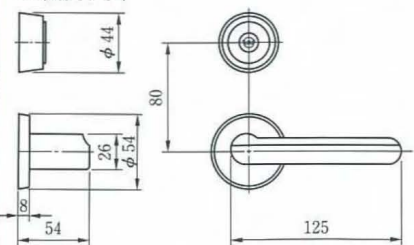

LEVER HANDLE

■納期:受注生産品(P3参照)

LG7676-0

空錠

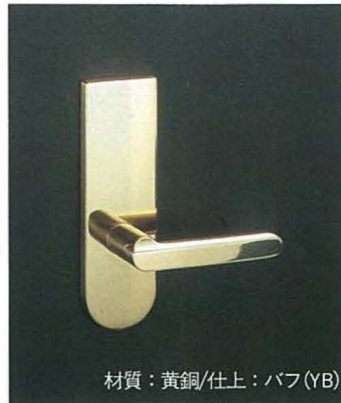
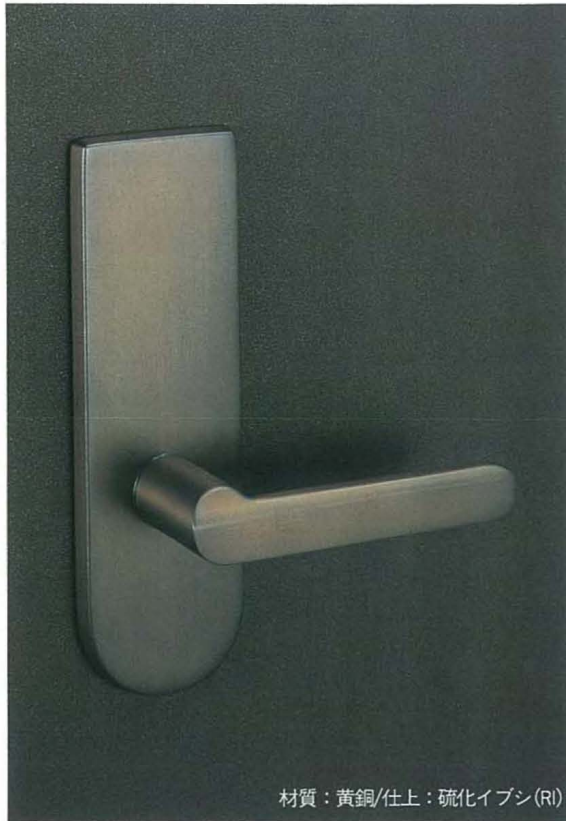

C70

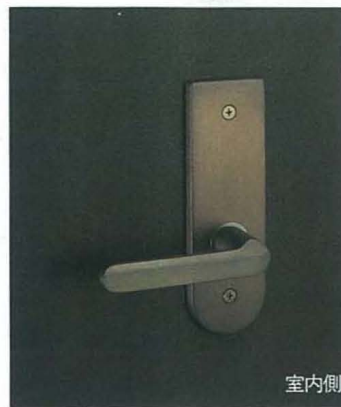

●外観寸法図

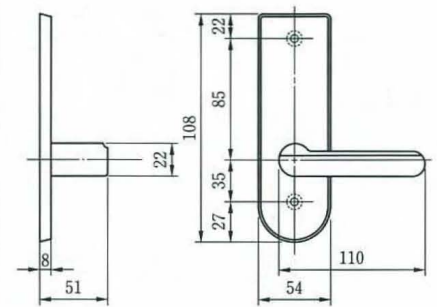

LG7677-0

空錠

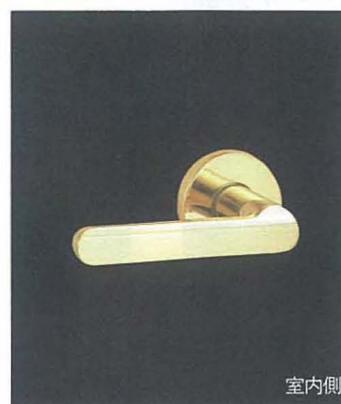
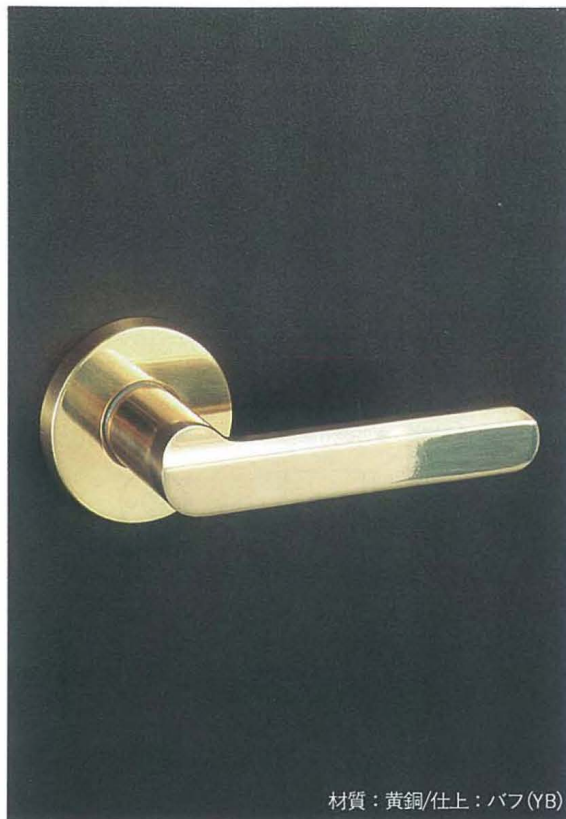

●外観寸法図

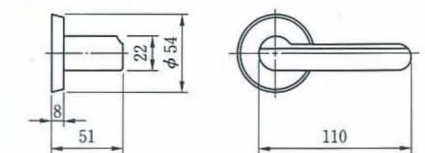

LEVER HANDLE

■納期：受注生産品(P3参照)

LG7676-6

非常開装置錠

C70

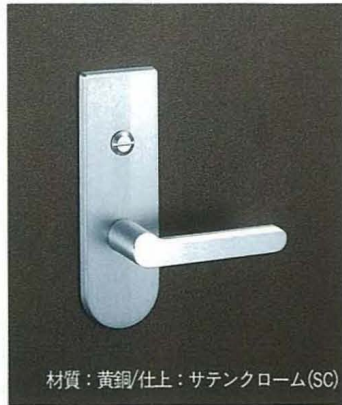
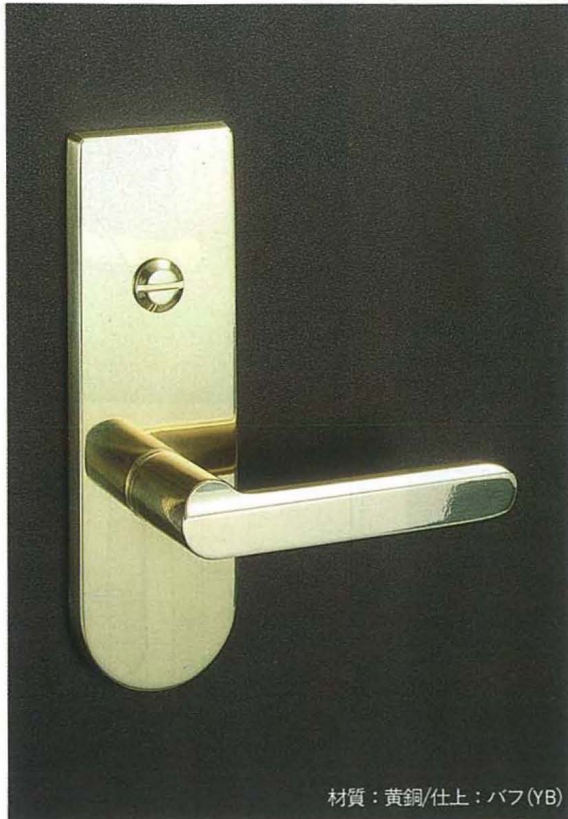

●外観寸法図

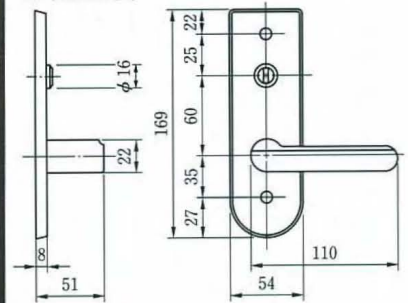

LG7677-6

非常開装置錠



●外観寸法図

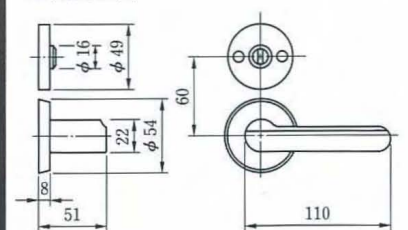

LEVER HANDLE

■納期：受注生産品(P3参照)

LG7676-8

表示付非常開装置錠

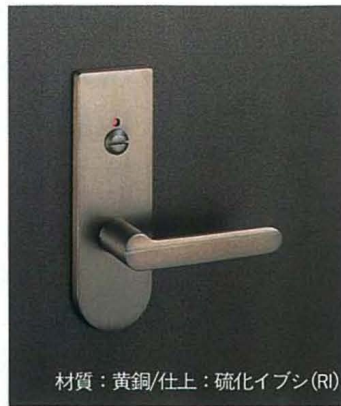

C70



●外観寸法図

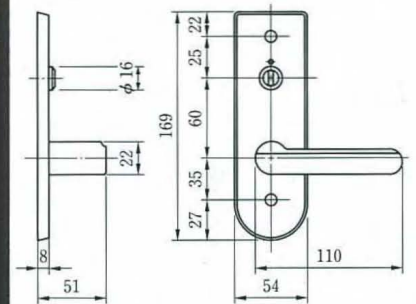

LG7677-8

表示付非常開装置錠

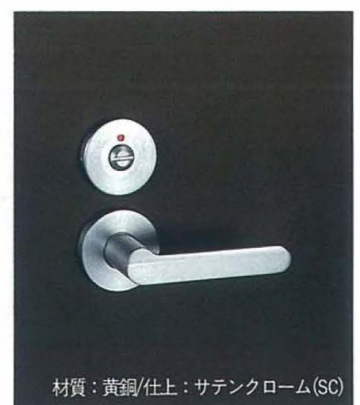
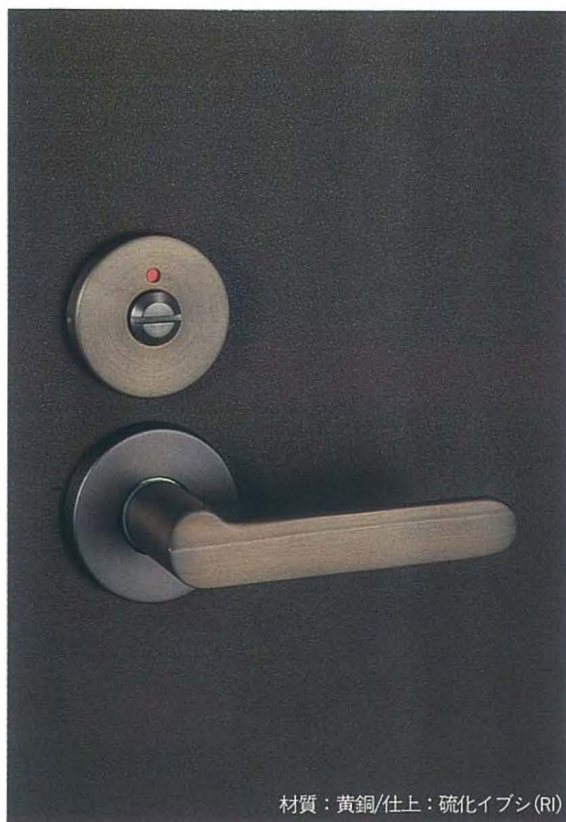

●外観寸法図

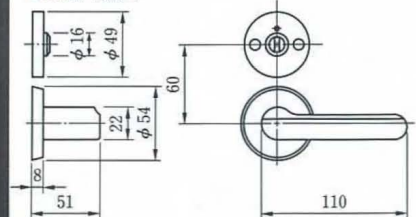

KNOB

■納期：受注生産品(P3参照)

U9MA7075-1

シリンダー錠

C70



●外観寸法図

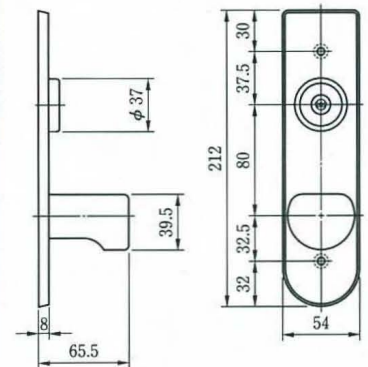

U9MA7070-1

シリンダー錠

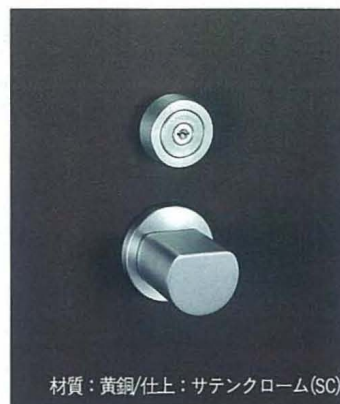
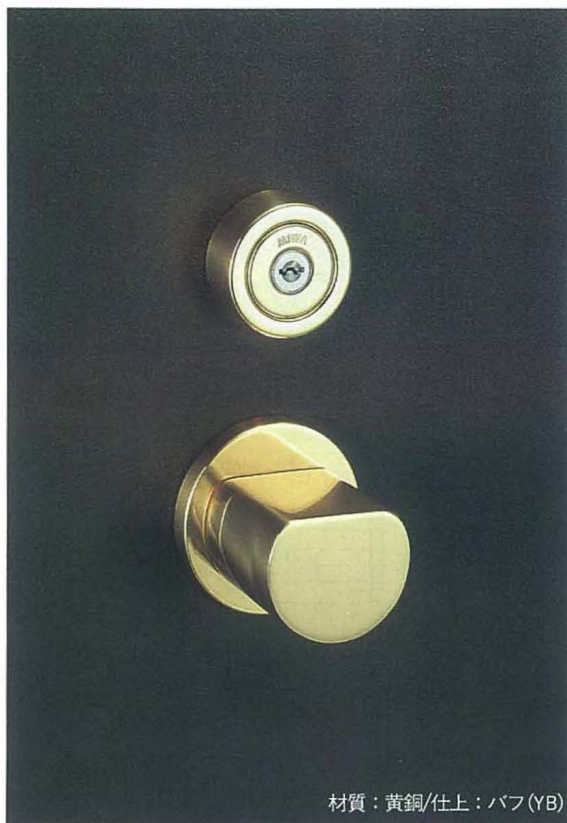

●外観寸法図

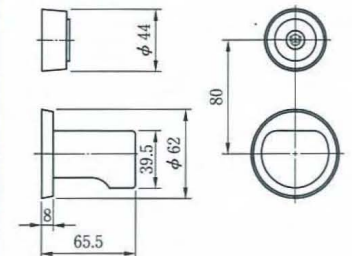

KNOB

■納期:受注生産品(P3参照)

MG7076-0

空錠



C70



●外觀寸法図

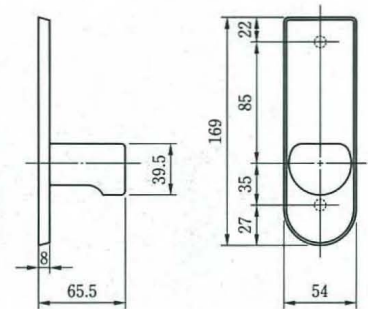

MG7070-0

空錠

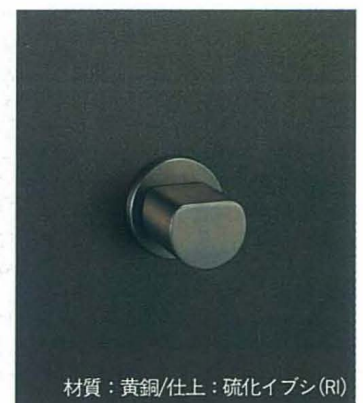
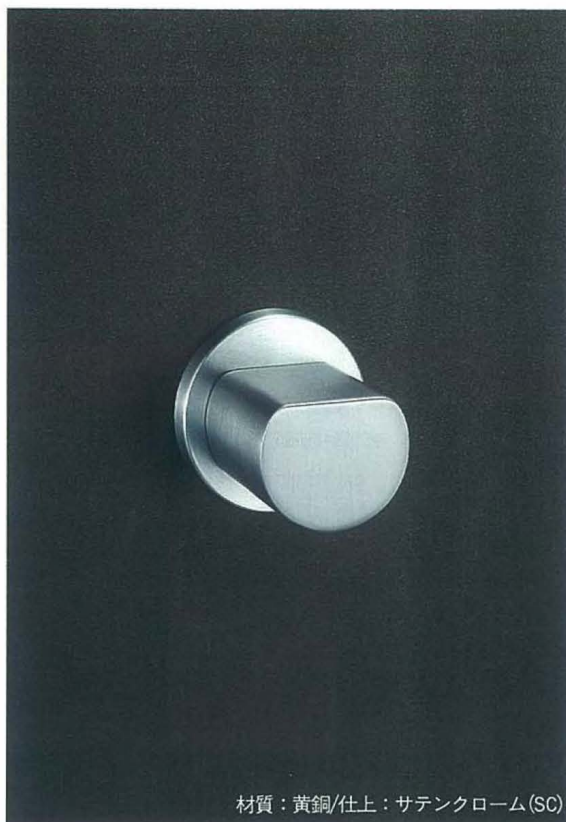

●外觀寸法図

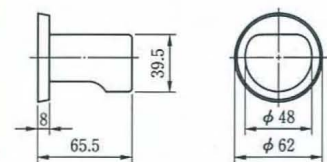

KNOB

■納期：受注生産品(P3参照)

MG7076-6

非常開装置錠

C70

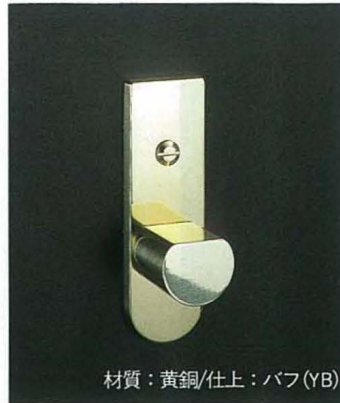

●外観寸法図

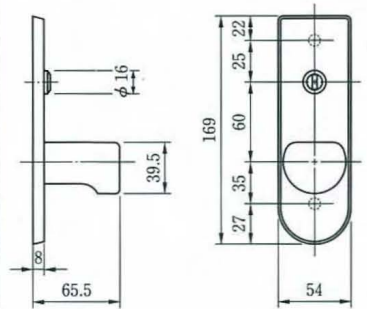

MG7070-6

非常開装置錠

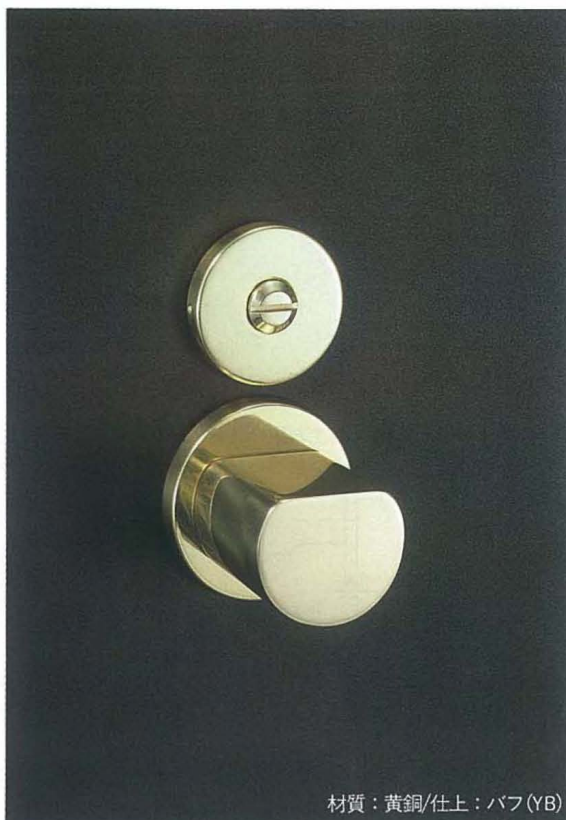

●外観寸法図

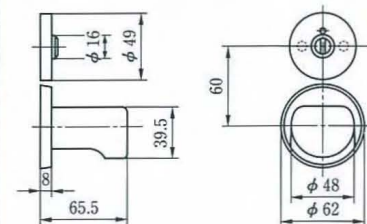

KNOB

■納期：受注生産品(P3参照)

MG7076-8

表示付非常開装置錠

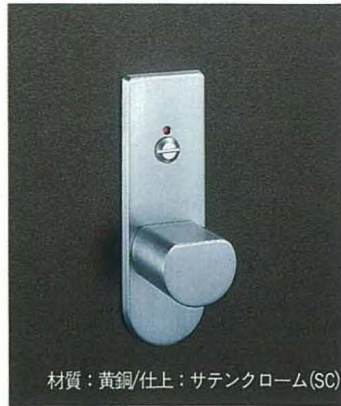
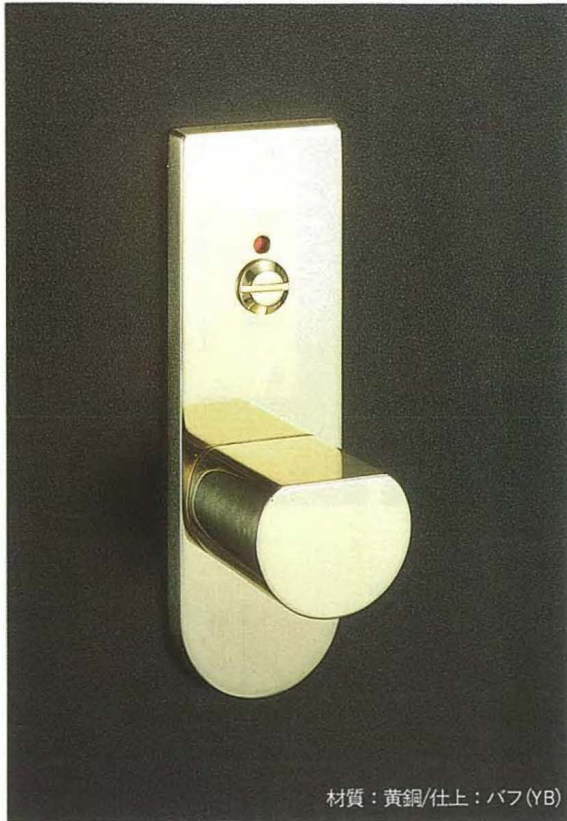

C70



●外觀寸法図

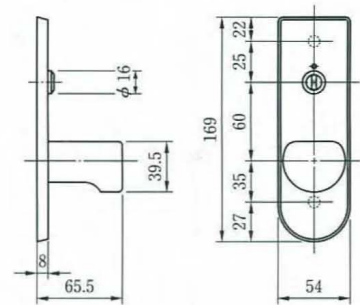

MG7070-8

表示付非常開装置錠



●外觀寸法図

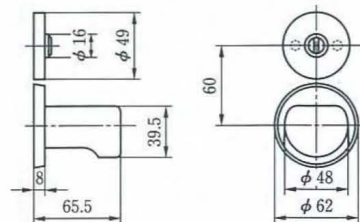

儀星丁番 / フランス丁番

■納期：受注生産品(P3参照)

B70127, B70102

儀星丁番

C70

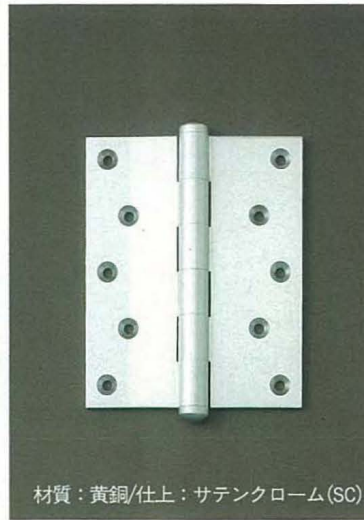
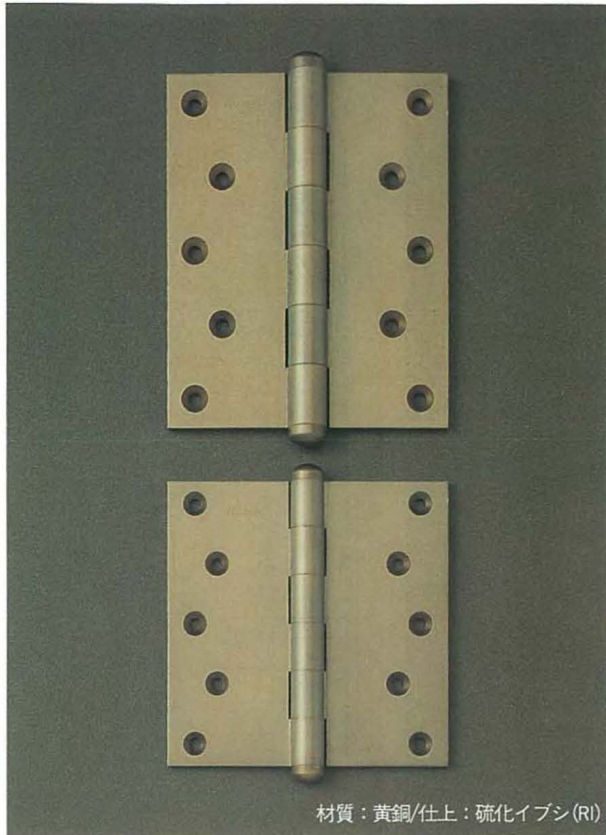

●外観寸法図

B70127

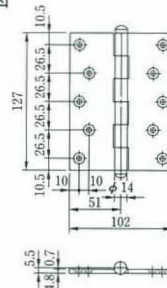

B70102

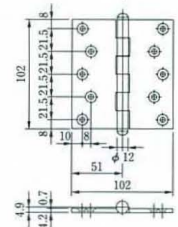

F70127, F70102

フランス丁番

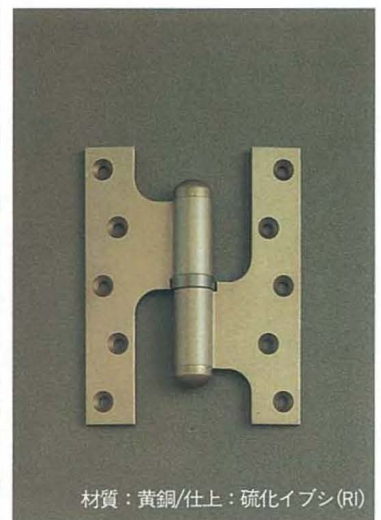
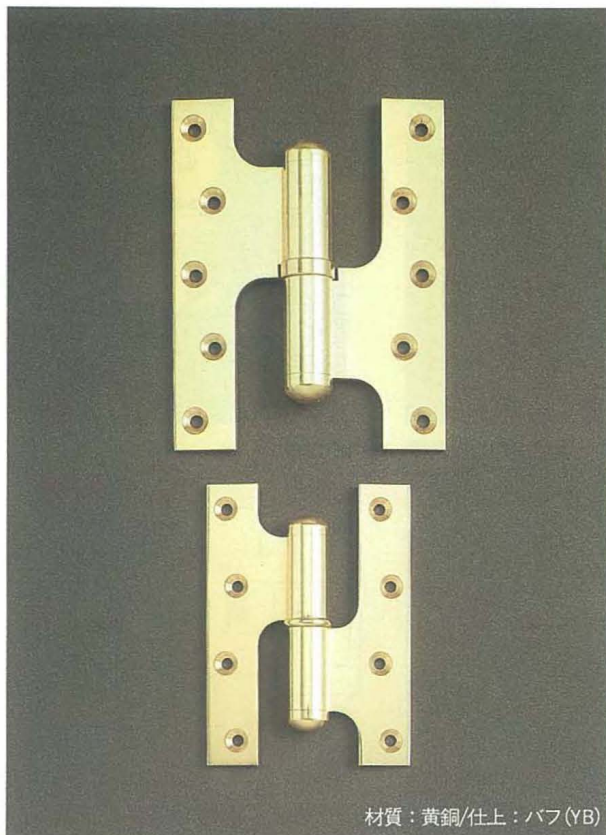

●外観寸法図

F70127

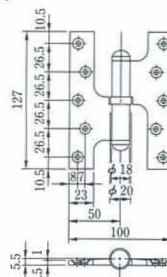

F70102

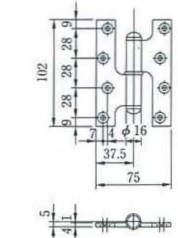

取手/ツマミ

■納期:受注生産品(P3参照)

T70108, T70093, T70078, T70063

取手

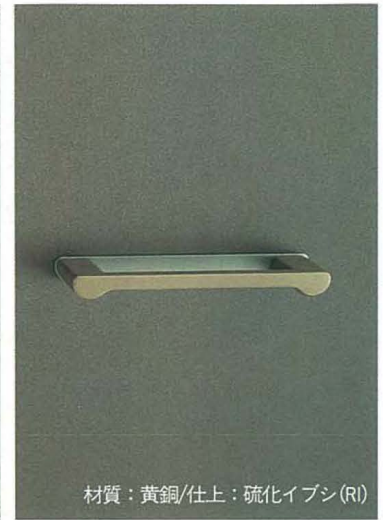
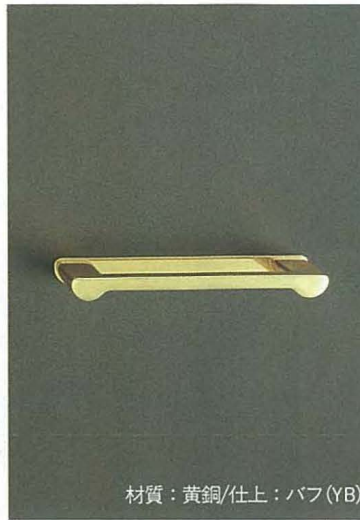
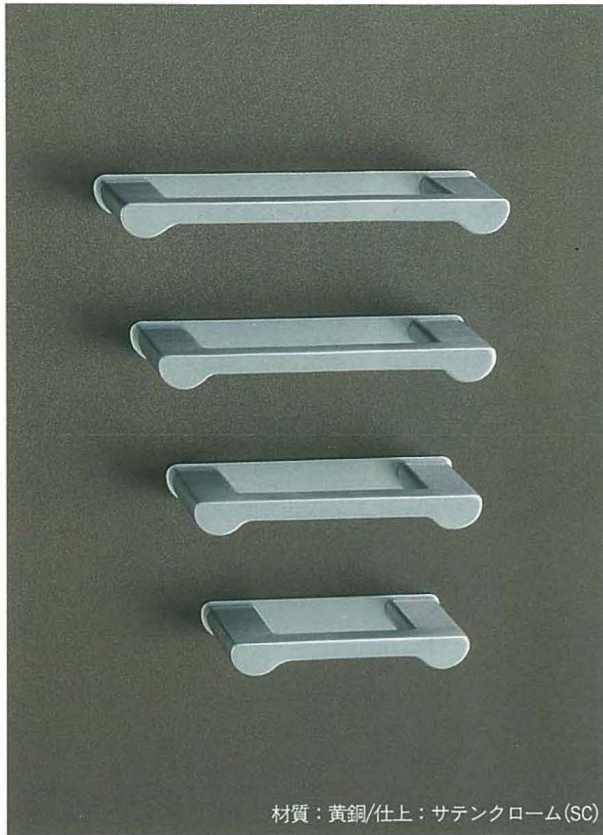

C70

●外観寸法図

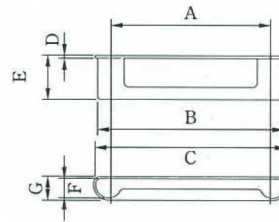

取手	A	B	C	D	E	F	G
T70108	108	126	128	1	29	12	14
T70093	93	111	113	1	29	12	14
T70078	78	96	98	1	29	12	14
T70063	63	81	83	1	29	12	14

P70028, P70022, P70018

ツマミ

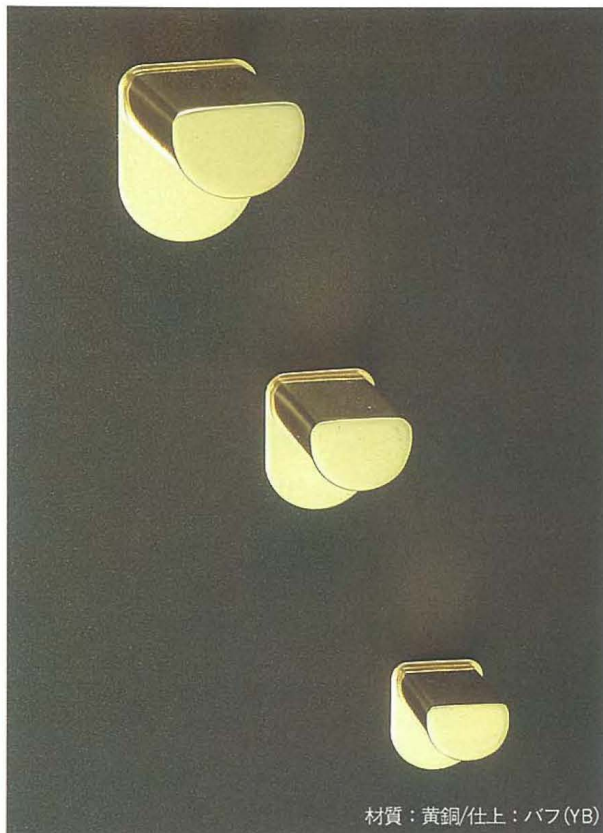

●外観寸法図

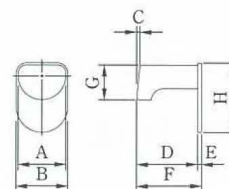

ツマミ	A	B	C	D	E	F	G	H
T70028	28	30	2	37	1	38	20	40
T70022	22	24	1.5	30	1	31	16	32
T70018	18	20	1	24	1	25	13	26

彫込引手

■納期：受注生産品(P3参照)

H70130 H70105

彫込引手

C70

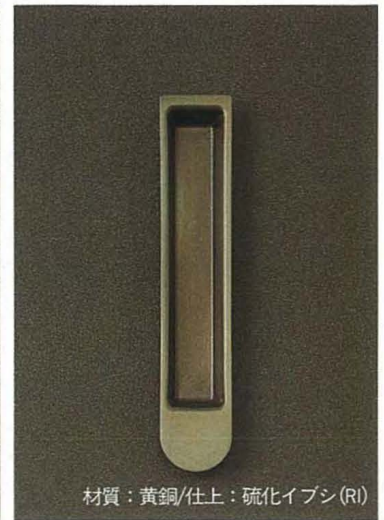
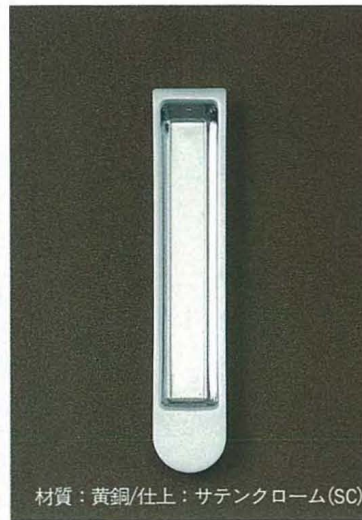
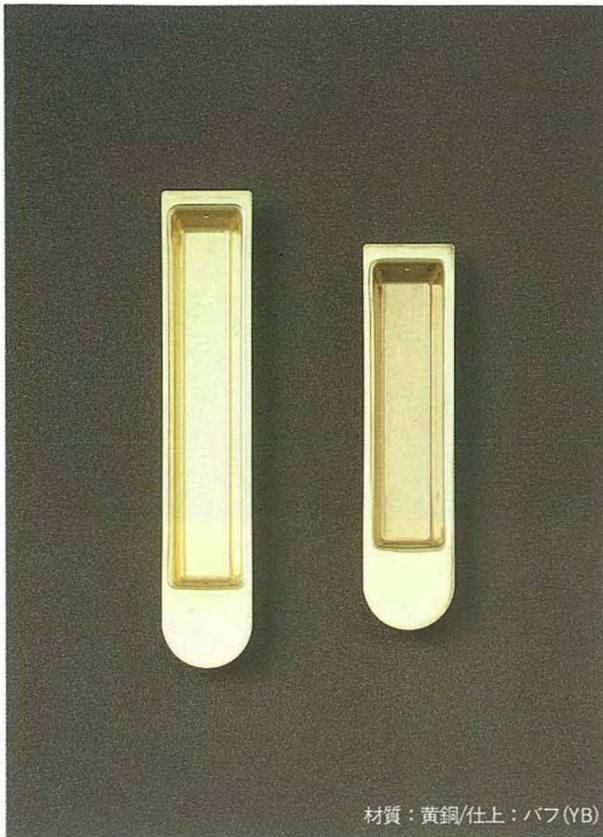

●外観寸法図

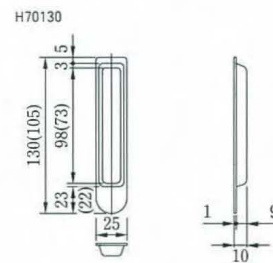

●C70シリーズについての詳細は専用カタログをご請求ください。

C70 SERIES

※シリンダーはU9シリンダーのみです。

U9LA7575-1

バックセット (mm) 51・64
扉厚可能範囲 33~42
(mm以上~mm未満)

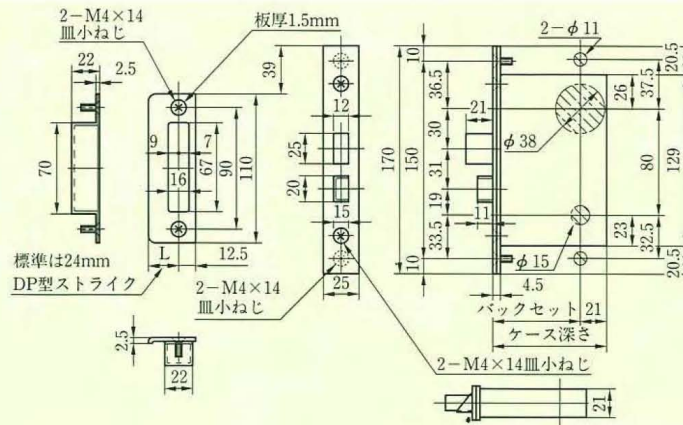

(注)その他の扉厚についてはお問い合わせください。

U9MA7075-1

バックセット (mm) 64・76
扉厚可能範囲 33~42
(mm以上~mm未満)

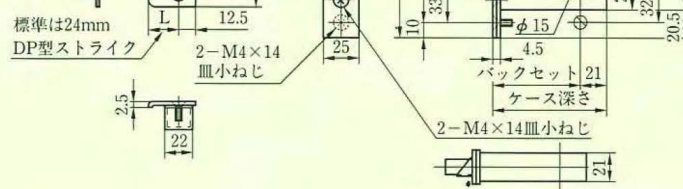

(注)その他の扉厚についてはお問い合わせください。

U9LA7577-1

バックセット (mm) 51・64
扉厚可能範囲 33~42
(mm以上~mm未満)

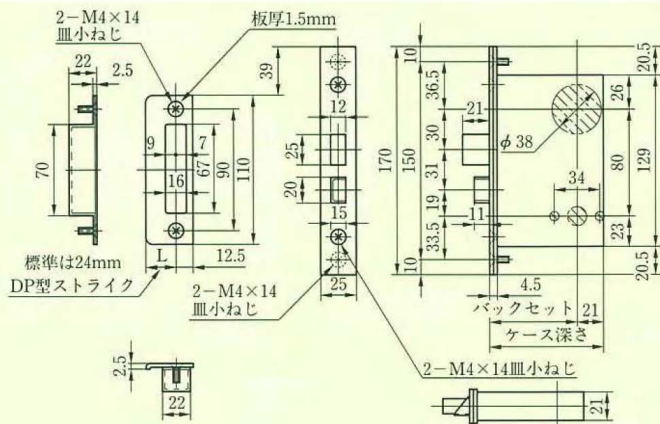

(注)その他の扉厚についてはお問い合わせください。

LG7676-0

バックセット (mm) 51・64
扉厚可能範囲 33~42
(mm以上~mm未満)

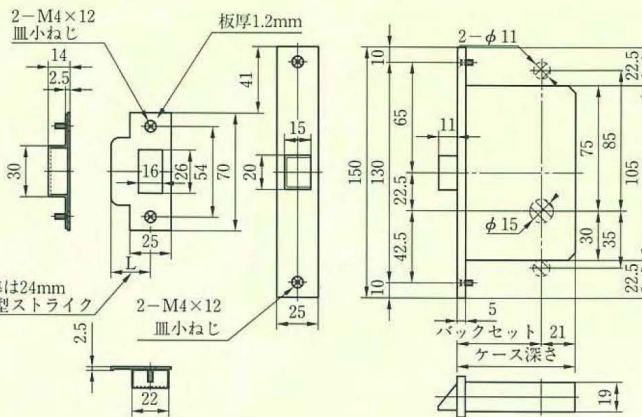

(注)その他の扉厚についてはお問い合わせください。

MG7076-0

バックセット (mm) 64
扉厚可能範囲 33~42
(mm以上~mm未満)



(注)その他の扉厚についてはお問い合わせください。

LG7677-0

バックセット (mm) 51・64
扉厚可能範囲 33~42
(mm以上~mm未満)

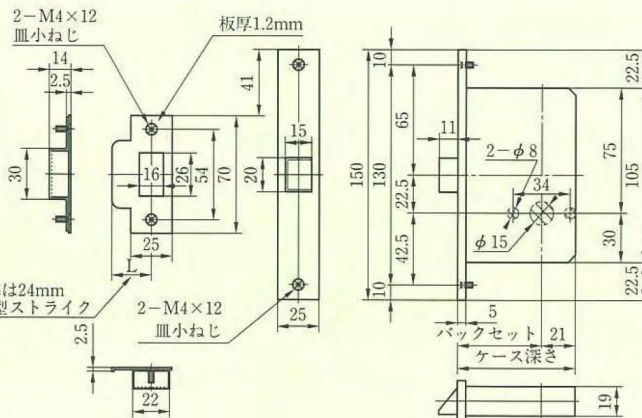

(注)その他の扉厚についてはお問い合わせください。

MG7070-0

バックセット (mm) 64
扉厚可能範囲 33~42
(mm以上~mm未満)



(注)その他の扉厚についてはお問い合わせください。

C70

C70 SERIES

※シリンダーはU9シリンダーのみです。

LG7676-6

LG7676-8

バックセット (mm) 51・64

扉厚可能範囲 33~42

(mm以上~mm未満)

MG7076-6

MG7076-8

バックセット (mm) 64

扉厚可能範囲 33~42

(mm以上~mm未満)

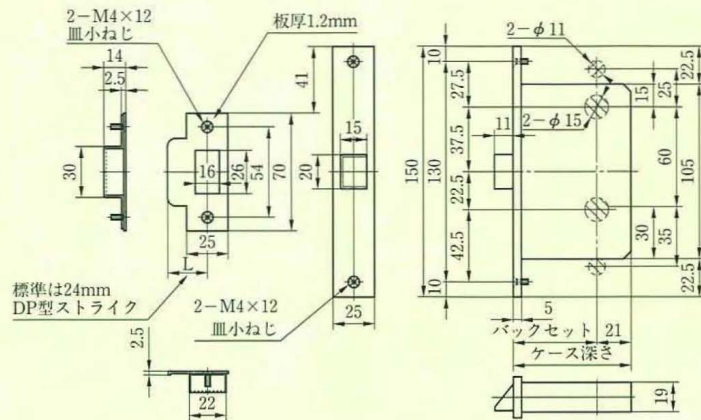

(注)その他の扉厚についてはお問合わせください。

LG7677-6

LG7677-8

バックセット (mm) 51・64

扉厚可能範囲 33~42

(mm以上~mm未満)

MG7070-6

MG7070-8

バックセット (mm) 64

扉厚可能範囲 33~42

(mm以上~mm未満)

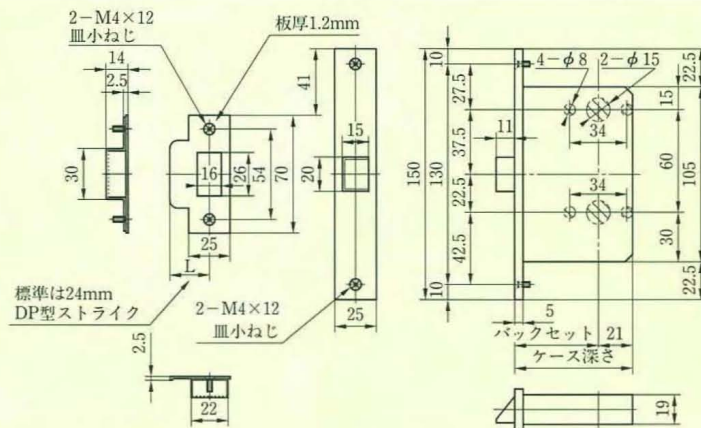

(注)その他の扉厚についてはお問合わせください。

U9MA7070-1

バックセット (mm) 64・76

扉厚可能範囲 33~42

(mm以上~mm未満)

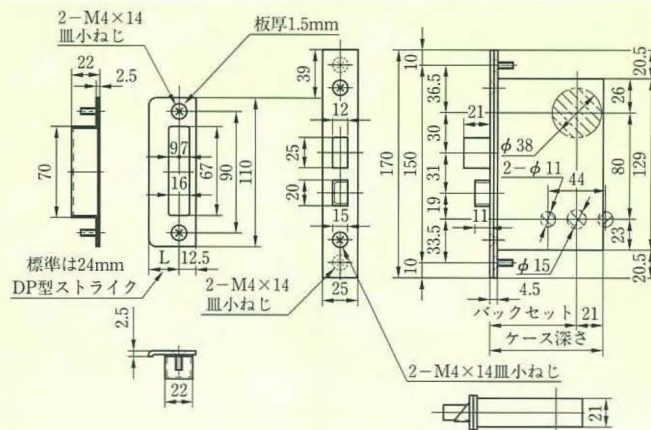

(注)その他の扉厚についてはお問合わせください。